

Mill - Thread Inserts and Kits



**Mill-Thread tools for threading on CNC milling machines
by using helical interpolation programs**

Advantages of Mill-Thread Tools

- Same toolholder and insert can produce both right-hand and left-hand threads.
- A single insert & toolholder can produce a given thread on many diameters (External & Internal).
- Prismatic shape of insert's tail ensures exact and reliable clamping in the toolholder.
- Most inserts are double sided, having two cutting edges.
- Thread is produced in one tool pass.
- MT tools can produce tapered threads.
- Improved productivity thanks to increased cutting speeds and multitooth type carbide inserts.
- Threading to one pitch of a shoulder in a blind hole.
- Longer tool life thanks to a special multilayer coating process.
- Lower tooling costs, considerably less expensive than using taps and dies.
- Since lower machine power is required, a smaller machine can produce larger threads in a single operation with less idle time and tool changes.

Contents:

Page:

Contents:

Page:

Product Identification 68
ISO 69
UN 70
WHIT 71
BSPT 71
NPT 72
NPTF 72
NPS 73
NPSF 73

PG - DIN 40430 74
UNJ 74
American Buttress 75
Acme 75
Internal UN Kits 76
Special Tools 77

Product Identification

Mill-Thread Inserts Ordering Codes

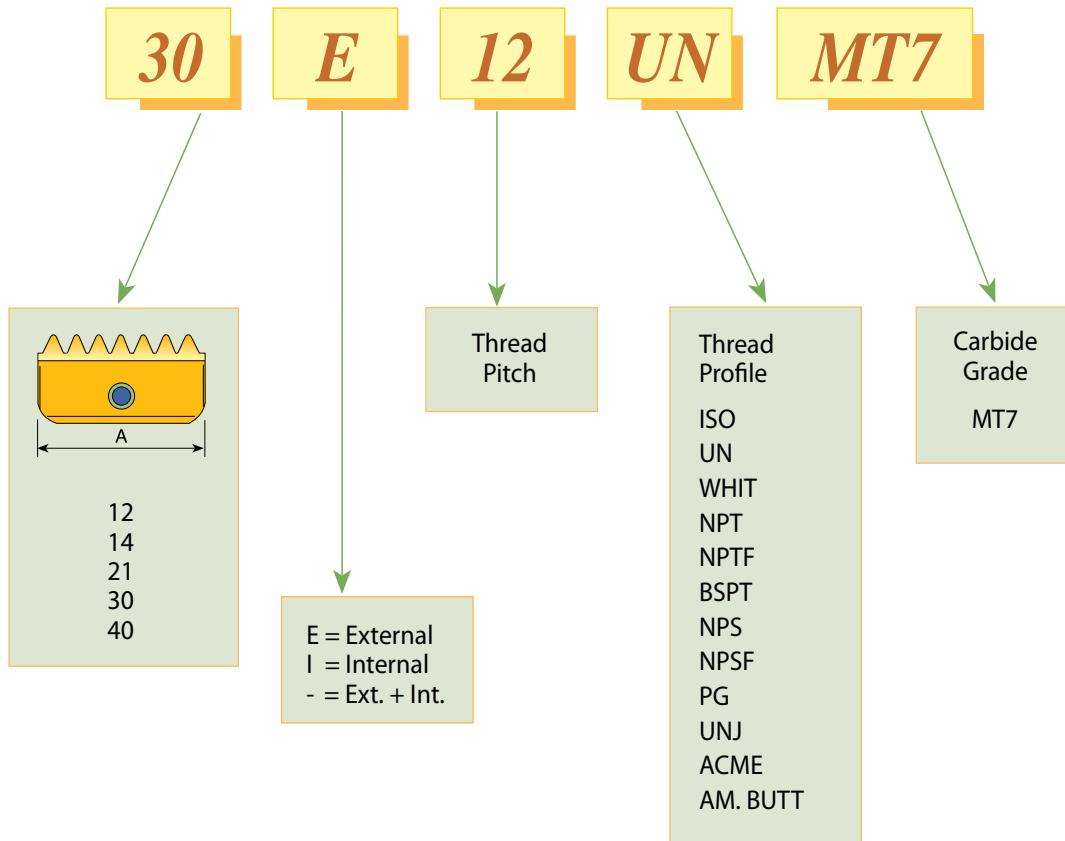

ISO

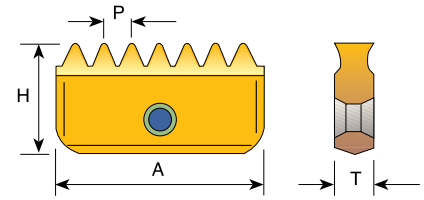
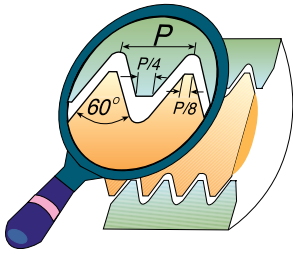

Pitch mm		Insert Size = A				
		12 mm .472	14 mm .551	21 mm .827	30 mm 1.181	40 mm 1.575
0.5	Ext.					
0.5	Int.	* 12 I 0.5 ISO	14 I 0.5 ISO			
0.75	Ext.		14 E 0.75 ISO			
0.75	Int.	* 12 I 0.75 ISO	14 I 0.75 ISO			
1.0	Ext.		14 E 1.0 ISO	21 E 1.0 ISO		
1.0	Int.	* 12 I 1.0 ISO	14 I 1.0 ISO	21 I 1.0 ISO		
1.25	Ext.		14 E 1.25 ISO			
1.25	Int.	* 12 I 1.25 ISO	14 I 1.25 ISO			
1.5	Ext.		14 E 1.5 ISO	21 E 1.5 ISO	30 E 1.5 ISO	40 E 1.5 ISO
1.5	Int.	* 12 I 1.5 ISO	14 I 1.5 ISO	21 I 1.5 ISO	30 I 1.5 ISO	40 I 1.5 ISO
1.75	Ext.		14 E 1.75 ISO			
1.75	Int.		14 I 1.75 ISO	21 I 1.75 ISO		
2.0	Ext.		14 E 2.0 ISO	21 E 2.0 ISO	30 E 2.0 ISO	40 E 2.0 ISO
2.0	Int.		14 I 2.0 ISO	21 I 2.0 ISO	30 I 2.0 ISO	40 I 2.0 ISO
2.5	Ext.		14 E 2.5 ISO	21 E 2.5 ISO		
2.5	Int.		14 I 2.5 ISO	21 I 2.5 ISO		
3.0	Ext.			21 E 3.0 ISO	30 E 3.0 ISO	40 E 3.0 ISO
3.0	Int.			21 I 3.0 ISO	30 I 3.0 ISO	40 I 3.0 ISO
3.5	Ext.				30 E 3.5 ISO	
3.5	Int.			21 I 3.5 ISO	30 I 3.5 ISO	40 I 3.5 ISO
4.0	Ext.				30 E 4.0 ISO	40 E 4.0 ISO
4.0	Int.				30 I 4.0 ISO	40 I 4.0 ISO
4.5	Ext.					
4.5	Int.				30 I 4.5 ISO	40 I 4.5 ISO
5.0	Ext.					40 E 5.0 ISO
5.0	Int.				30 I 5.0 ISO	40 I 5.0 ISO
5.5	Ext.					
5.5	Int.				30 I 5.5 ISO	40 I 5.5 ISO
6.0	Ext.					40 E 6.0 ISO
6.0	Int.					40 I 6.0 ISO
H		.248	.295	.472	.630	.787
T		.114	.122	.185	.217	.248

* One cutting edge

Order example: 14 I 1.5 ISO MT7

UN UNC, UNF, UNEF, UNS

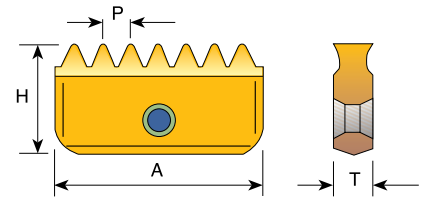
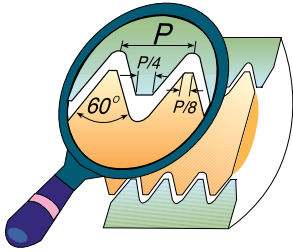

Pitch TPI		Insert Size = A				
		12 mm .472	14 mm .551	21 mm .827	30 mm 1.181	40 mm 1.575
32	Ext.		14 E 32 UN			
32	Int.	* 12 32 UN	14 32 UN			
28	Ext.		14 E 28 UN			
28	Int.	* 12 28 UN	14 28 UN			
27	Ext.					
27	Int.		14 27 UN			
24	Ext.		14 E 24 UN	21 E 24 UN		
24	Int.	* 12 24 UN	14 24 UN	21 24 UN		
20	Ext.		14 E 20 UN	21 E 20 UN	30 E 20 UN	
20	Int.	* 12 20 UN	14 20 UN	21 20 UN	30 20 UN	
18	Ext.		14 E 18 UN	21 E 18 UN	30 E 18 UN	
18	Int.	* 12 18 UN	14 18 UN	21 18 UN	30 18 UN	
16	Ext.		14 E 16 UN	21 E 16 UN	30 E 16 UN	40 E 16 UN
16	Int.	* 12 16 UN	14 16 UN	21 16 UN	30 16 UN	40 16 UN
14	Ext.		14 E 14 UN	21 E 14 UN	30 E 14 UN	40 E 14 UN
14	Int.		14 14 UN	21 14 UN	30 14 UN	40 14 UN
12	Ext.		14 E 12 UN	21 E 12 UN	30 E 12 UN	40 E 12 UN
12	Int.		14 12 UN	21 12 UN	30 12 UN	40 12 UN
11	Ext.		14 E 11 UN	21 E 11 UN		
11	Int.		14 11 UN			
10	Ext.		14 E 10 UN	21 E 10 UN	30 E 10 UN	40 E 10 UN
10	Int.		14 10 UN	21 10 UN	30 10 UN	40 10 UN
9	Ext.					
9	Int.		** 14 9 UN			
8	Ext.				30 E 8 UN	40 E 8 UN
8	Int.			21 8 UN	30 8 UN	40 8 UN
7	Ext.					
7	Int.			21 7 UN		
6	Ext.				30 E 6 UN	40 E 6 UN
6	Int.				30 6 UN	40 6 UN
5	Ext.					
5	Int.				30 5 UN	
4.5	Ext.					
4.5	Int.					40 4.5UN
4	Ext.					
4	Int.					40 4 UN
H		.248	.295	.472	.630	.787
T		.114	.122	.185	.217	.248

* One cutting edge

** Cannot be used with carbide shank Toolholders.

Order example: 21 | 18 UN MT7

WHIT BSW, BSF, BSP

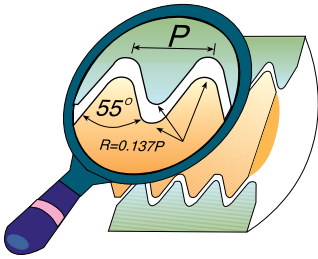

Same Insert for External and Internal thread.

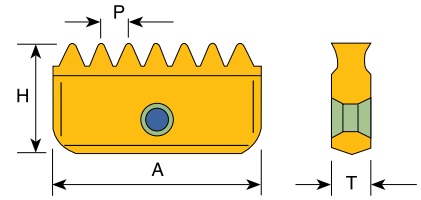

Pitch TPI	Insert Size = A				
	12 mm .472	14 mm .551	21 mm .827	30 mm 1.181	40 mm 1.575
24		14-24 W			
20		14-20 W	21-20 W		
19	* 12 - 19 W	14-19 W	21-19 W		
16		14-16 W	21-16 W	30-16 W	
14		14-14 W	21-14 W	30-14 W	
11		14-11 W	21-11 W	30-11 W	40-11 W
8					40- 8 W
H	.248	.295	.472	.630	.787
T	.114	.122	.185	.217	.248

* One cutting edge

Order example: 21-11 W MT7

BSPT

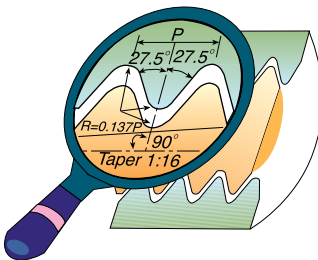

Conical pipe thread inserts are one-sided and may be used for both External and Internal threading.

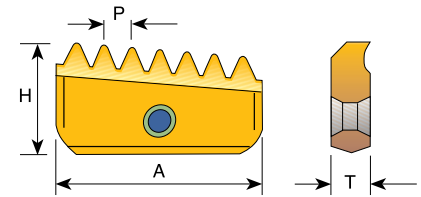

Pitch TPI	Insert Size = A				
	12 mm .472	14 mm .551	21 mm .827	30 mm 1.181	40 mm 1.575
19	12-19 BSPT	14-19 BSPT			
14		14-14 BSPT	21-14 BSPT		
11			21-11 BSPT	30-11 BSPT	40-11 BSPT
H	.248	.295	.472	.630	.787
T	.114	.122	.185	.217	.248

Order example: 14-19 BSPT MT7

For conical preparation end mills see page 125

NPT

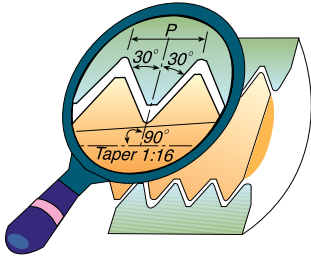

Conical pipe thread inserts are one-sided and may be used for both External and Internal threading.

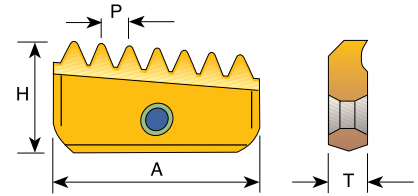

Pitch TPI	Insert Size = A				
	12 mm .472	14 mm .551	21 mm .827	30 mm 1.181	40 mm 1.575
18	12-18 NPT	14-18 NPT			
14		14-14 NPT	21-14 NPT		
11.5			21-11.5 NPT	30-11.5 NPT	40-11.5 NPT
8				30- 8 NPT	40- 8 NPT
H	.248	.295	.472	.630	.787
T	.114	.122	.185	.217	.248

Order example: 30-11.5 NPT MT7

NPTF

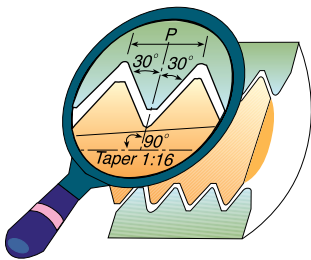

Conical pipe thread inserts are one-sided and may be used for both External and Internal threading.

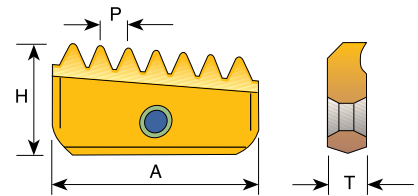

Pitch TPI	Insert Size = A				
	12 mm .472	14 mm .551	21 mm .827	30 mm 1.181	40 mm 1.575
18	12-18 NPTF	14-18 NPTF			
14		14-14 NPTF	21-14 NPTF		
11.5			21-11.5 NPTF	30-11.5 NPTF	40-11.5 NPTF
8				30- 8 NPTF	40- 8 NPTF
H	.248	.295	.472	.630	.787
T	.114	.122	.185	.217	.248

Order example: 21-14 NPTF MT7

For conical preparation end mills see page 125

NPS

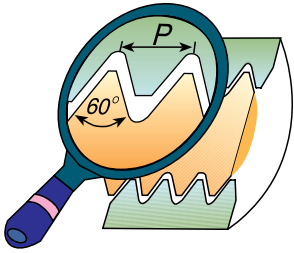

Same Insert for External and Internal thread

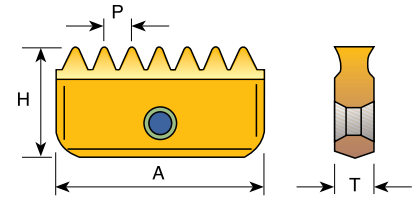

Pitch TPI	Insert Size = A				
	12 mm .472	14 mm .551	21 mm .827	30 mm 1.181	40 mm 1.575
18	* 12-18 NPS	14-18 NPS			
14		14-14 NPS	21-14 NPS		
11.5			21-11.5 NPS	30-11.5 NPS	40-11.5 NPS
8				30- 8 NPS	40- 8 NPS
H	.248	.295	.472	.630	.787
T	.114	.122	.185	.217	.248

Order example: 30-11.5 NPS MT7

* One cutting edge

NPSF

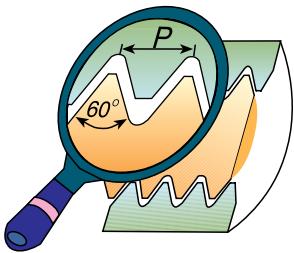

Same Insert for External and Internal thread

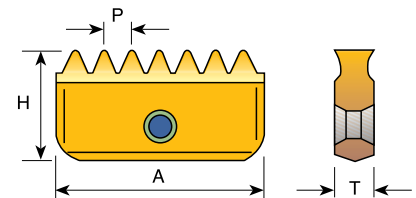

Pitch TPI	Insert Size = A				
	12 mm .472	14 mm .551	21 mm .827	30 mm 1.181	40 mm 1.575
18	* 12-18 NPSF	14-18 NPSF			
14		14-14 NPSF	21-14 NPSF		
11.5			21-11.5 NPSF	30-11.5 NPSF	40-11.5 NPSF
8				30- 8 NPSF	40- 8 NPSF
H	.248	.295	.472	.630	.787
T	.114	.122	.185	.217	.248

Order example: 21-14 NPSF MT7

* One cutting edge

PG - DIN 40430

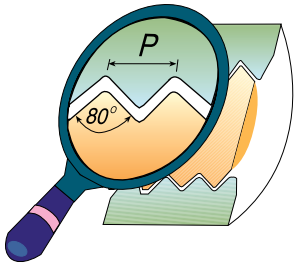

Same Insert for External and Internal thread

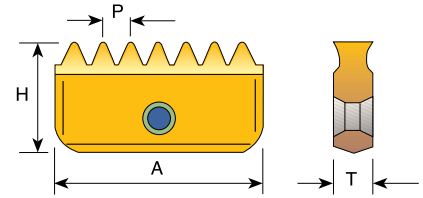

Pitch TPI	Insert Size = A		
	14 mm .551	21 mm .827	30 mm 1.181
18	14-18 PG (PG 9, 11, 13.5, 16)	21-18 PG (PG 16)	
16		21-16 PG (PG 21, 29, 36, 42, 48)	30-16 PG (PG 36, 42, 48)
H	.295	.472	.630
T	.122	.185	.217

Order example: 21-18 PG MT7

UNJ

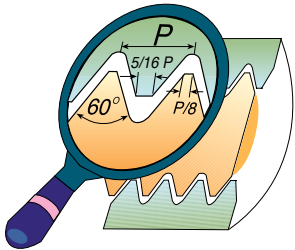

Inserts for External thread

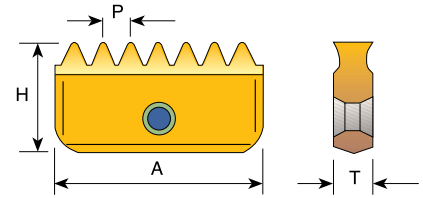

Pitch TPI		Insert Size = A	
		14 mm .551	21 mm .827
24	Ext.	14 E 24 UNJ	21 E 24 UNJ
20	Ext.	14 E 20 UNJ	21 E 20 UNJ
18	Ext.	14 E 18 UNJ	21 E 18 UNJ
16	Ext.	14 E 16 UNJ	21 E 16 UNJ
14	Ext.	14 E 14 UNJ	21 E 14 UNJ
12	Ext.	14 E 12 UNJ	21 E 12 UNJ
H		.295	.472
T		.122	.185

Order example: 21E 16 UNJ MT7

For internal UNJ threads it is common to use UN inserts as partial profile.

American Buttress

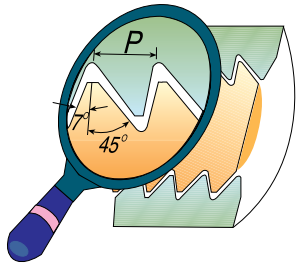

ABUT thread inserts are one-sided and may be used for both External and Internal threading

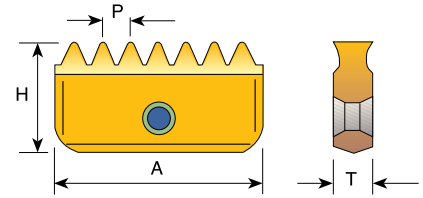

Pitch TPI	Insert Size = A		
	21 mm .827	30 mm 1.181	40 mm 1.575
16	21 - 16 ABUT	30 - 16 ABUT	
12	21 - 12 ABUT	30 - 12 ABUT	
10	21 - 10 ABUT	30 - 10 ABUT	
8	21 - 8 ABUT	30 - 8 ABUT	
6		30 - 6 ABUT	
4		* 30 - 4 ABUT	40 - 4 ABUT
H	.472	.630	.787
T	.185	.217	.248

Order example: 30 - 6 ABUT MT7

* Inserts to be used only on Multi-Insert toolholders see page 83

ACME

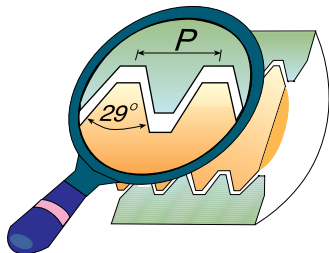

Inserts for Internal threads

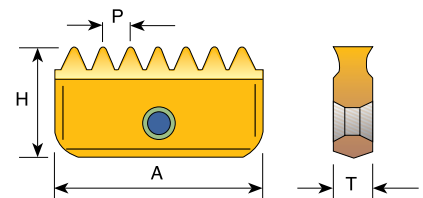

Pitch TPI		Insert Size = A		
		21 mm .827	30 mm 1.181	40 mm 1.575
12	Int.	21 12 ACME	30 12 ACME	
10	Int.	21 10 ACME	30 10 ACME	
8	Int.	21 8 ACME	30 8 ACME	
6	Int.		30 6 ACME	
5	Int.		30 5 ACME	
4	Int.		* 30 4 ACME	40 4 ACME
3.5	Int.			40 3.5 ACME
3	Int.			** 40 3 ACME
H		.472	.630	.787
T		.185	.217	.248

Order example: 21 | 8 ACME MT7

* Inserts to be used only on Multi-Insert toolholders see page 83

** One cutting edge

Internal UN Kits

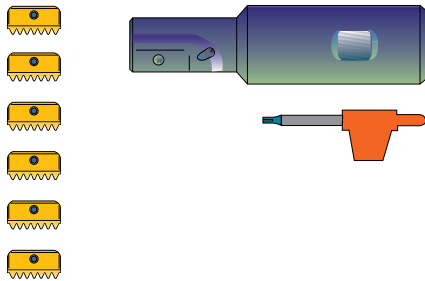

MTK 12 UN	MTK 14 UN
<u>INSERTS</u>	<u>INSERTS</u>
12 32 UN	14 24 UN
12 24 UN	14 24 UN
12 20 UN	14 20 UN
12 20 UN	14 20 UN
12 16 UN	14 16 UN
12 16 UN	14 16 UN
<u>TOOLHOLDER</u>	<u>TOOLHOLDER</u>
SR 0375 H12	SR 0670 H14
<u>KEY</u>	<u>KEY</u>
K12	K14
<u>SCREW</u>	<u>SCREW</u>
S12	S14

Order example : MTK 14 | UN

Mill-Thread Toolholders



Contents:

Page:

Product Identification	80
Single Insert Toolholders	81
Long Shank Toolholders	81
Twin Insert Toolholders	82
Multi Insert Toolholders	83
External Multi Insert Toolholders	83
Long Carbide Shank Toolholders	84
Carbide Shank Toolholders for Single Point Threading	84

Product Identification

Mill-Thread Toolholders Ordering Codes

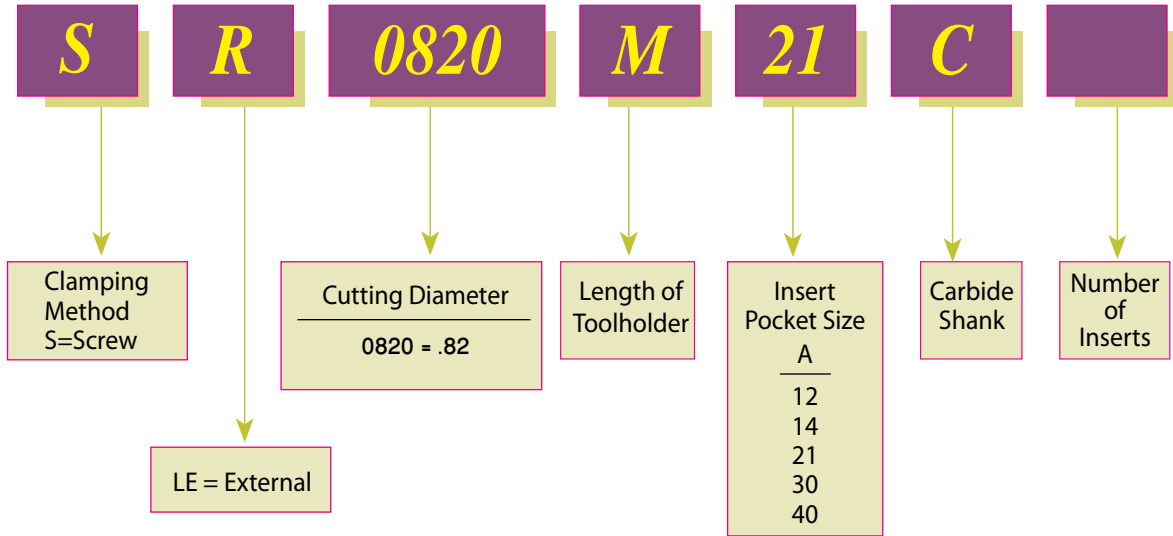

Single Insert Toolholders

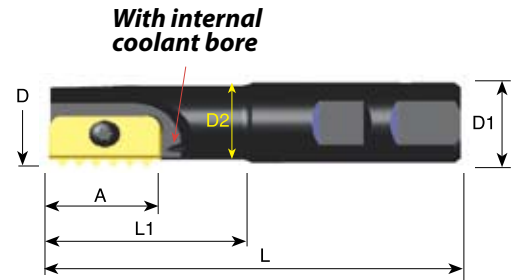

Ordering Code	A mm	D	D1	D2	L	L1	Insert Screw	Torx Key
SR0375H12	12	.37	.75	.30	3.35	.51	S12	K12
*SR0390H12	12	.39	.75	.30	3.35	.51	S12	K12
SR0500F14	14	.50	.75	.37	2.95	.70	S14	K14
SR0540F14	14	.54	.75	.38	2.98	.77	S14	K14
SR0570H14	14	.57	.75	.41	3.20	1.00	S14	K14
SR0670H14	14	.67	.75	.53	3.35	1.18	S14	K14
SR0790H21	21	.79	.75	.61	3.70	1.57	S21	K21
SR0790K21	21	.79	.75	.61	5.00	2.25	S21	K21
SR1140J30	30	1.14	1.00	.88	4.27	1.85	S30	K30
SR1500P40	40	1.50	1.25	1.13	7.00	4.25	S40	K40
SR1500R40	40	1.50	1.25	1.13	8.00	5.25	S40	K40
SR1730M40	40	1.73	1.50	1.38	6.02	3.19	S40	K40

Order example: SR0790H21

* For conical inserts: 12-18 NPT, 12-18 NPTF, 12-19 BSPT

Long Shank Toolholders

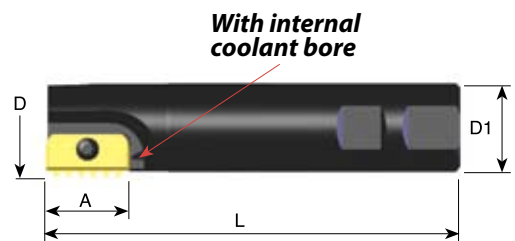

Ordering Code	A mm	D	D1	L	Insert Screw	Torx Key
SR0940K21	21	.94	.75	5.00	S21	K21
SR1240M30	30	1.24	1.00	6.00	S30	K30
SR1500M30	30	1.50	1.25	6.00	S30	K30

Order example: SR1240M30

For holders with long overhang reduce the cutting speed and feed rate between 20% to 40% (depends on workpiece material, pitch and overhang)

Twin Insert Toolholders

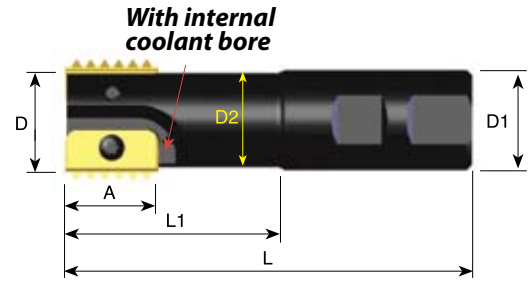

Ordering Code	A mm	D	D1	D2	L	L1	No. of Inserts	Insert Screw	Torx Key
SR0790H14-2	14	.79	.75	.63	3.66	1.54	2	S14	K14
SR1180J21-2	21	1.18	1.00	.95	4.25	1.97	2	S21	K21
SR1580L30-2	30	1.57	1.25	1.18	5.12	2.80	2	S30	K30
SR1970M40-2	40	1.97	1.50	1.49	6.02	3.35	2	S40	K40

Order example: SR1580L30-2

Multi Insert Toolholders

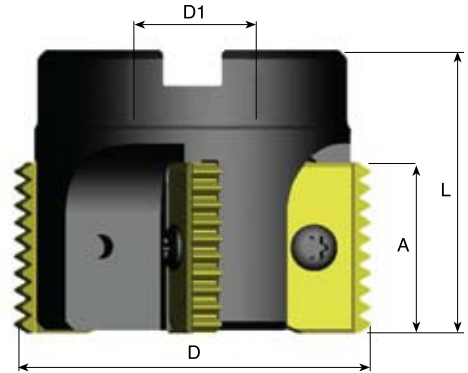

Ordering Code	A mm	D	D1	L	No. of Inserts	Insert Screw	Torx Key
SR2480C21-5	21	2.48	.75	1.97	5	S21	K21
SR2480C30-4	30	2.48	.75	1.97	4	S30	K30
SR3150D30-4	30	3.15	1.00	2.16	4	S30	K30
SR3940D30-4	30	3.94	1.25	2.36	4	S30	K30
SR3940D30-8	30	3.94	1.25	2.36	8	S30	K30
SR3150D40-4	40	3.15	1.00	2.56	4	S40	K40
SR3940E40-4	40	3.94	1.25	2.76	4	S40	K40
SR3940E40-6	40	3.94	1.25	2.76	6	S40	K40

Order example: SR3940D30-4

External Multi Insert Toolholder

- Reduced machining time
- Optimal coolant supply

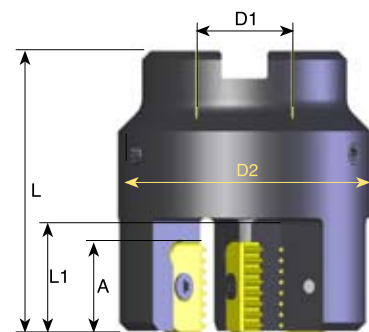
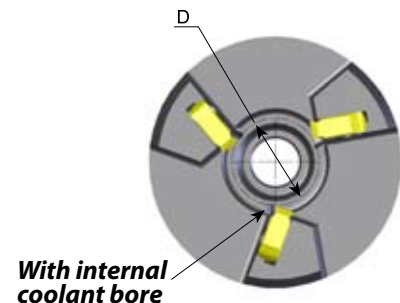
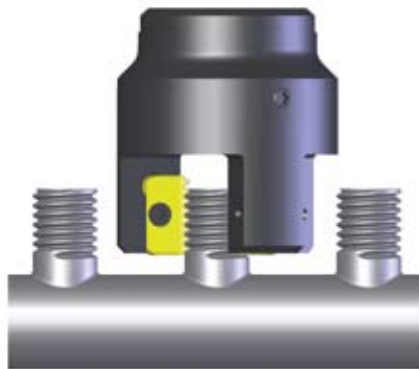

Ordering Code	A mm	D	D1	D2	L	L1	No. of Inserts	Insert Screw	Torx Key
SLE0790D21-3	21	.79	.75	2.28	2.56	.95	3	S21	K21
SLE1180D21-3	21	1.18	.75	2.68	2.56	.95	3	S21	K21
SLE1770E21-4	21	1.77	1.00	3.27	2.76	.95	4	S21	K21

Order example: SLE1180D21-3

Long Carbide Shank Toolholders



With internal coolant bore

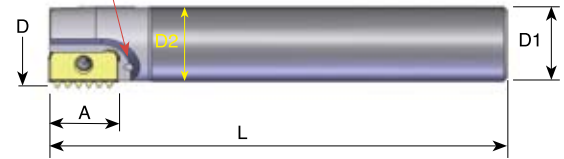

Ordering Code	A mm	D	D1	D2	L	Insert Screw	Torx Key
SR0390K12C	12	.39	.312	.312	5.0	S12	K12
SR0500J14C	14	.50	.375	.375	6.0	S14	K14
SR0620K14C	14	.62	.500	.500	7.0	S14	K14
SR0820M21C	21	.82	.625	.625	8.0	S21	K21

Order example: SR0620 K14C

For holders with long overhang reduce the cutting speed and feed rate between 20% to 40% (depends on workpiece material, pitch and overhang)

Carbide Shank Toolholders for Single Point Threading



With internal coolant bore

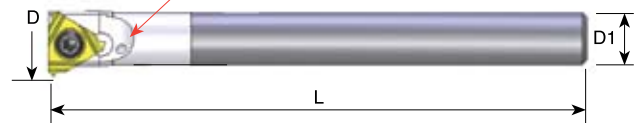

Ordering Code	L mm	Pitch Range		D	D1	L	Insert Screw	Torx Key
		mm	TPI					
* SR0250H08C	08	0.5-1.75	48-14	.35	.25	4.0	S08	K08
** SR0375M11C	11	0.5-2.00	48-11	.50	.38	6.0	S11	K11

For Inserts see the Thread Turning Tools section of this Catalogue

For an internal application use an internal R.H. insert.

* Without coolant bore

** For an external application use an external L.H. insert.

Special Tools



In addition to standard products, Carmex manufactures special tools and inserts according to customers' requests. Special tools are supplied in short delivery times.

