

Mini Chamfer



Advantages

Carbide grade: MT8 Sub-micron grade with advanced PVD triple coating (ISO K10-K20). Extremely high heat resistant and smooth cutting operation, for high performance, and normal machining conditions. General purpose for all materials.

- Optimal for deburring, back chamfering and grooving.
- Double side cutting.
- Spiral flute allows smooth cutting action.

Contents:

Page:

Product Identification	324
Mini Chamfer	325-326
Mini Chamfer Kit	327
Special Solid Carbide Tools	327

Product Identification Mini Chamfer Ordering Codes

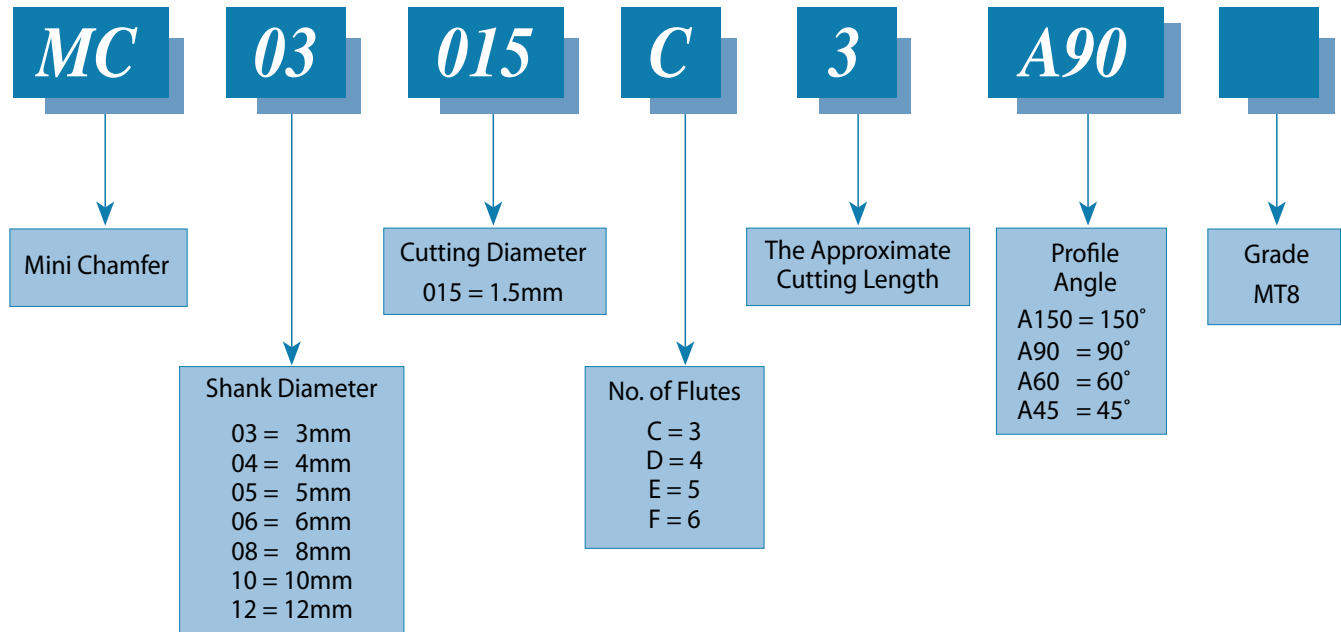

Mini Chamfer

Metric Shanks

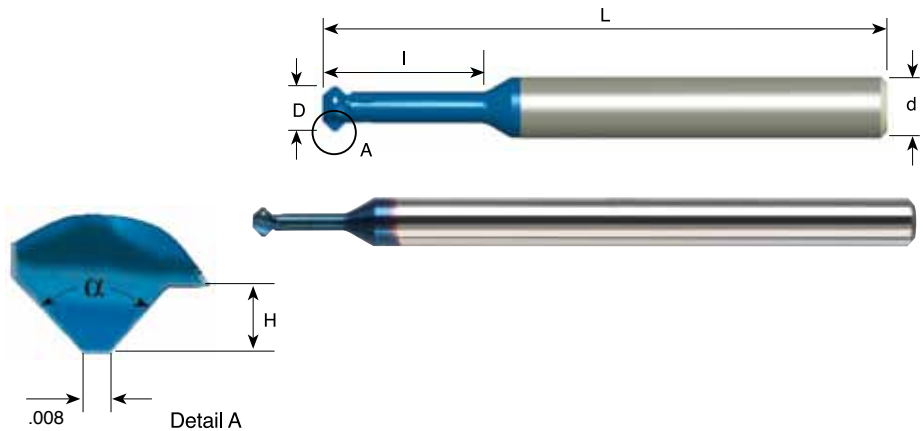

90°

Ordering Code	d mm	D	I	H	α	No. of Flutes	L
MC03015C3 A90	3	.059	.15	.012	90°	3	1.5
MC0302C5 A90	3	.079	.20	.016	90°	3	1.5
MC03025C6 A90	3	.098	.25	.020	90°	3	1.5
MC0303C7 A90	3	.118	.30	.024	90°	3	1.5
MC04035C9 A90	4	.138	.35	.028	90°	3	2.0
MC0404C10 A90	4	.157	.39	.031	90°	3	2.0
MC05045C11 A90	5	.177	.44	.039	90°	3	2.0
MC0505C12 A90	5	.197	.49	.043	90°	3	2.0
MC06055C13 A90	6	.217	.54	.047	90°	3	2.0
MC0606C15 A90	6	.236	.59	.059	90°	3	2.0

Long Reach 90°

Ordering Code	d mm	D	I	H	B	α	No. of Flutes	L
MC0303C12 A90	3	.118	.47	.024	.028	90°	3	1.5
MC04035C14 A90	4	.138	.55	.028	.031	90°	3	2.0
MC0404C16 A90	4	.157	.63	.031	.035	90°	3	2.0
MC0404C16L A90	4	.157	.63	.031	.035	90°	3	4.1
MC05045C18 A90	5	.177	.71	.039	.043	90°	3	2.0
MC0505C20 A90	5	.197	.79	.043	.047	90°	3	2.0
MC0505C20L A90	5	.197	.79	.043	.047	90°	3	4.1
MC06055C22 A90	6	.217	.87	.047	.051	90°	3	2.3
MC0606C24 A90	6	.236	.94	.059	.063	90°	3	2.3
MC0606C24L A90	6	.236	.94	.059	.063	90°	3	4.1
MC0808D28 A90	8	.315	1.10	.063	.067	90°	4	2.5
MC0808D28L A90	8	.315	1.10	.063	.067	90°	4	4.1
MC1010E35 A90	10	.394	1.38	.071	.075	90°	5	2.9
MC1212F42 A90	12	.472	1.65	.083	.087	90°	6	3.3

60°

Ordering Code	d mm	D	I	H	α	No. of Flutes	L
MC0302C5 A60	3	.079	.20	.016	60°	3	1.5
MC0303C7 A60	3	.118	.30	.024	60°	3	1.5
MC04035C9 A60	4	.138	.35	.028	60°	3	2.0
MC0404C10 A60	4	.157	.39	.031	60°	3	2.0
MC05045C11 A60	5	.177	.44	.039	60°	3	2.0
MC0505C12 A60	5	.197	.49	.043	60°	3	2.0

Mini Chamfer Metric Shanks

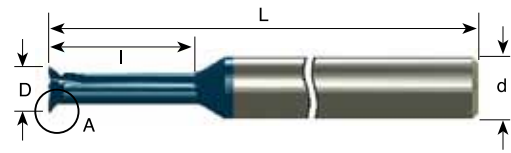
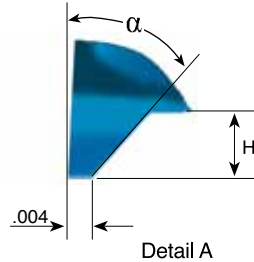
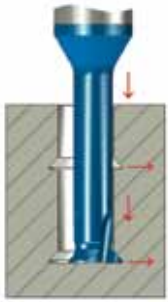

Dovetail 45°*

Ordering Code	d mm	D	l	H	α	No. of Flutes	L
MC03015C4 A45	3	.059	.18	.012	45°	3	1.5
MC0302C6 A45	3	.079	.24	.016	45°	3	1.5
MC03025C7 A45	3	.098	.30	.020	45°	3	1.5
MC0303C12 A45	3	.118	.47	.024	45°	3	1.5
MC04035C14 A45	4	.138	.55	.028	45°	3	2.0
MC0404C16 A45	4	.157	.63	.031	45°	3	2.0
MC05045C18 A45	5	.177	.71	.039	45°	3	2.0
MC0505C20 A45	5	.197	.79	.043	45°	3	2.0
MC06055C22 A45	6	.217	.87	.047	45°	3	2.3
MC0606C24 A45	6	.236	.94	.059	45°	3	2.3

* One side cutting

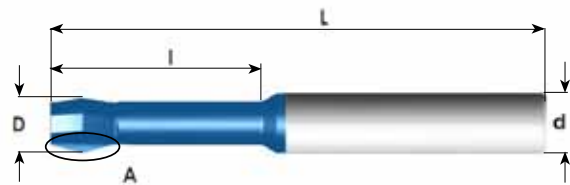
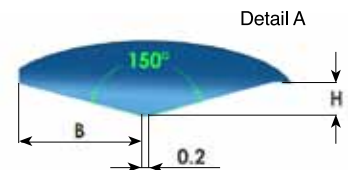
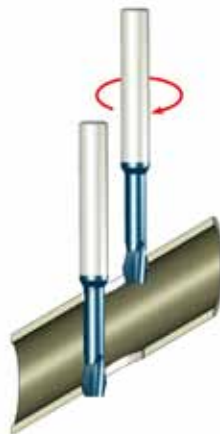

150°

Ordering Code	d mm	D	l	H	B	No. of Flutes	L
MC0303C12 A150	3	.118	.47	.024	.087	3	1.5
MC0404C16 A150	4	.157	.63	.031	.118	3	2.0
MC0404C16L A150	4	.157	.63	.031	.118	3	4.1
MC0505C20 A150	5	.197	.79	.039	.150	3	2.0
MC0505C20L A150	5	.197	.79	.039	.150	3	4.1
MC0606C24 A150	6	.236	.94	.039	.150	3	2.3
MC0606C24L A150	6	.236	.94	.039	.150	3	4.1
MC0808C28 A150	8	.315	1.10	.039	.150	3	2.5
MC0808C28L A150	8	.315	1.10	.039	.150	3	4.1

Order example: MC 0303 C12 A150 MT8

Mini Chamfer Kit

Kit KMC	Qty
MC 0303 C12 A90	1
MC 03025 C6 A90	1
MC 0404 C10 A90	1
MC 04035 C9 A90	1
MC 05045 C11 A90	1
MC 0606 C24 A90	1



Special Solid Carbide Tools



As part of being a service-orientated company, Carmex produces specials according to customer's requirements. Special tools are supplied in short delivery times.

