

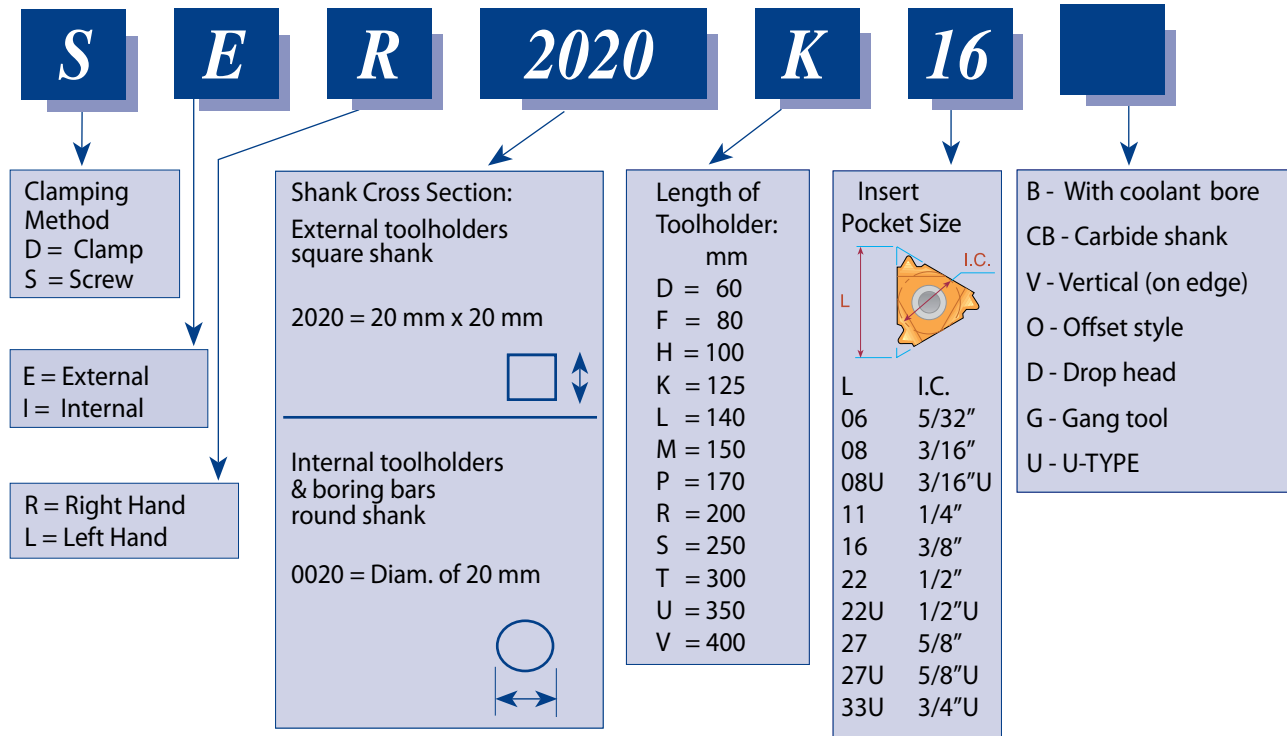

Contents:	Page:	Contents:	Page:
Product Identification	2	Star Toolholders Ø22	12
External Toolholders	3	Modular Line	13
Off-Set Toolholders	4	Applications	14
External Toolholders with Top Clamp	5	Product Identification	15
Vertical Toolholders	5	ML Turning Adaptors	16
Slim Throat Toolholders	5	Boring Bars	16
Drophead Toolholders	6	Quick Change	17
Gang Toolholders	6	External Toolholders	17
X-tream Jet:		Internal Toolholders	18
External Toolholder with Internal Coolant	7	Thread Helix Angle	19
Internal Toolholders	8	Standard and Slanted Anvils	19
Internal Toolholders with Coolant Bore	9	Anvil Kits	20
Internal Toolholders with Top Clamp	9	Standard Kits	21
Toolholders with 3.5° Helix Angle	9	Miniature & Ultra-Miniature Kits	21
Special Thread Turning Applications	10	Inserts' Kits	22
Carbide Shank Threading Bars	11	Threading & Boring Combination Kit	23
Vertical Toolholders	11		

Product Identification

Threading Toolholders Ordering Codes



External Toolholders

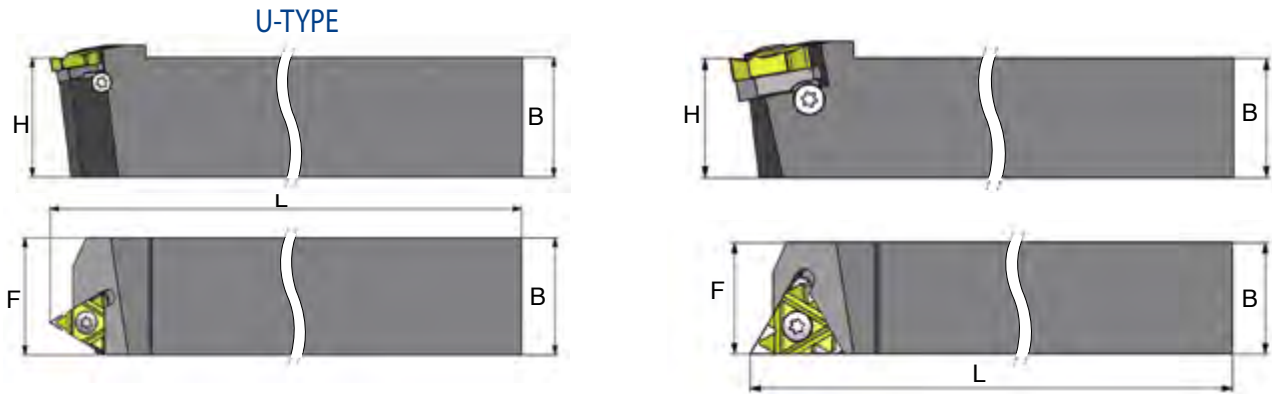

Ordering Code Right Hand		B=H	L	F	Insert Screw	Anvil Screw	Torx Key	RH Anvil	LH Anvil
*SER 8 8 H11	11	8	100	11	S11	-	K11	-	-
*SER 1010 H11	11	10	100	11	S11	-	K11	-	-
*SER 1010 M11	11	10	150	11	S11	-	K11	-	-
*SER 1212 K11	11	12	125	12	S11	-	K11	-	-
*SER 1212 M11	11	12	150	12	S11	-	K11	-	-
SER 1212 F16	16	12	80	16	S16	A16	K16	AE16	AI16
SER 1616 H16	16	16	100	16	S16	A16	K16	AE16	AI16
SER 2020 K16	16	20	125	20	S16	A16	K16	AE16	AI16
SER 2525 M16	16	25	150	25	S16	A16	K16	AE16	AI16
SER 3232 P16	16	32	170	32	S16	A16	K16	AE16	AI16
SER 2525 M22	22	25	150	25	S22	A22	K22	AE22	AI22
SER 3232 P22	22	32	170	32	S22	A22	K22	AE22	AI22
SER 4040 R22	22	40	200	40	S22	A22	K22	AE22	AI22
SER 2525 M22U	22U	25	150	28	S22	A22	K22	AE22U	AI22U
SER 3232 P22U	22U	32	170	32	S22	A22	K22	AE22U	AI22U
SER 4040 R22U	22U	40	200	40	S22	A22	K22	AE22U	AI22U
SER 2525 M27	27	25	150	32	S27	A27	K27	AE27	AI27
SER 3232 P27	27	32	170	32	S27	A27	K27	AE27	AI27
SER 4040 R27	27	40	200	40	S27	A27	K27	AE27	AI27
SER 2525 M27U	27U	25	150	32	S27	A27	K27	AE27U	AI27U
SER 3232 P27U	27U	32	170	32	S27	A27	K27	AE27U	AI27U
SER 4040 R27U	27U	40	200	40	S27	A27	K27	AE27U	AI27U
*SER 2525 M33U	33U	25	150	32	S33	-	K33	-	-
*SER 3232 P33U	33U	32	170	32	S33	-	K33	-	-

*Toolholders with no anvil

For **LEFT HAND** toolholders specify **SEL** instead of **SER**

Toolholders are made with a **1.5° Helix Angle**. For other Helix Angles please see helix angle chart (page A04-7) in the technical section of this catalog.

Off-Set Toolholders

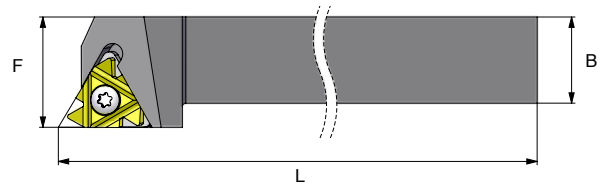
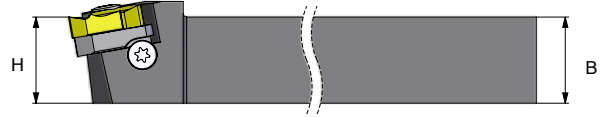
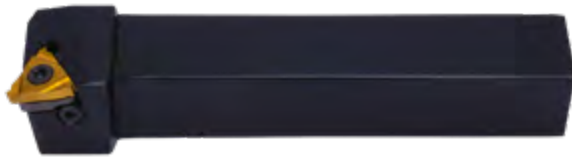

Ordering Code Right Hand	 L	B=H	L	F	Insert Screw	Anvil Screw	Torx Key	RH Anvil	LH Anvil
SER 1212 F16-O	16	12	8	16	S16	A16	K16	AE16	AI16
SER 1616 H16-O	16	16	100	20	S16	A16	K16	AE16	AI16
SER 2020 K16-O	16	20	125	25	S16	A16	K16	AE16	AI16
SER 2525 M16-O	16	25	150	32	S16	A16	K16	AE16	AI16
SER 3232 P16-O	16	32	170	40	S16	A16	K16	AE16	AI16
SER 2525 M22-O	22	25	150	32	S22	A22	K22	AE22	AI22
SER 3232 P22-O	22	32	170	40	S22	A22	K22	AE22	AI22

External Toolholders With Top Clamp

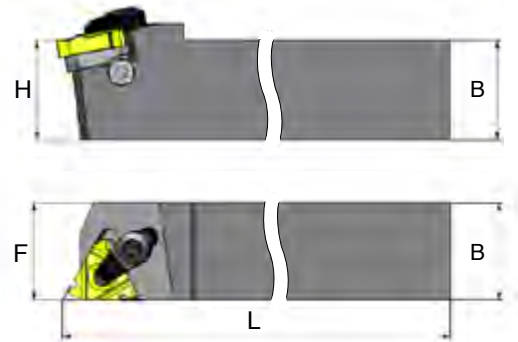

Ordering Code Right Hand	 L	B=H	L	F	Insert Screw	Clamp	Anvil Screw	Torx Key	RH Anvil	LH Anvil
DER 1212 H16	16	12	100	16	S16	C16	A16S	K16	AE16	AI16
DER 1616 H16	16	16	100	16	S16	C16	A16S	K16	AE16	AI16
DER 2020 K16	16	20	125	20	S16	C16	A16S	K16	AE16	AI16
DER 2525 M16	16	25	150	25	S16	C16	A16S	K16	AE16	AI16
*DER 2525 M22	22	25	150	25	S22	C22	A22	K22	AE22	AI22

For **LEFT HAND** toolholders specify **DEL** instead of **DER**
 Toolholders are made with a **1.5° Helix Angle**. For other Helix Angles
 please see helix angle chart in the technical section of this catalog.
 Two clamping methods can be used: screw or top clamp.
 *Use K21 torx key for C22 clamp

Vertical Toolholders

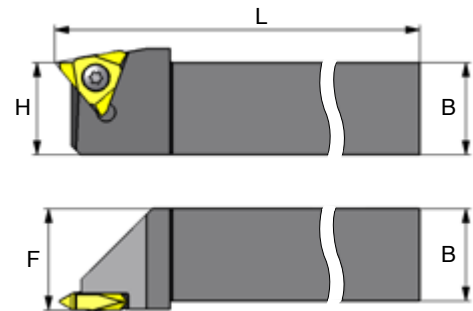
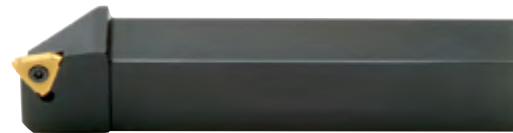

Ordering Code Right Hand		B=H	L	F	Insert Screw	Torx Key
SER 1616 H16V	16	16	100	18	S16S	K16
SER 2020 K16V	16	20	125	22	S16S	K16
SER 2525 M16V	16	25	150	27	S16S	K16
SER 2525 M22V	22	25	150	27.5	S22S	K22
SER 3232 P27V-T10	27	32	170	36	S27	K27

Slim Throat Toolholders

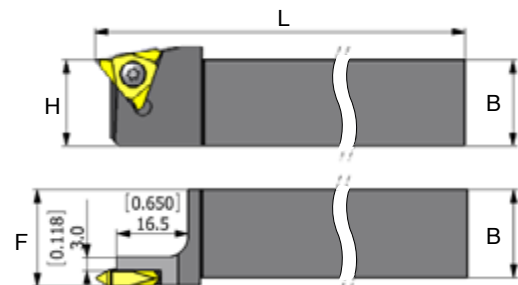

Ordering Code Right Hand		B=H	L	F	Insert Screw	Torx Key
SER 1616 H16VS	16	16	100	18	S16S	K16
SER 2020 K16VS	16	20	125	22	S16S	K16
SER 2525 M16VS	16	25	150	27	S16S	K16
SER 2525 M22VS	22	25	150	27	S22S	K22

Drophead Toolholders

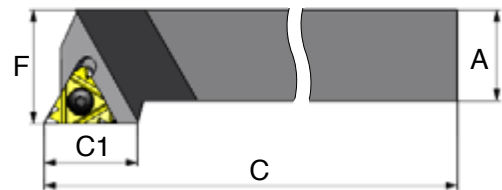
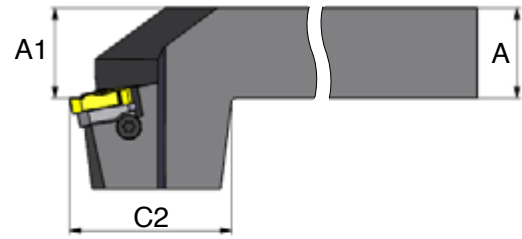

Ordering Code Right Hand	 L	A	A1	C	C1	F	C2	Insert Screw	Anvil Screw	Torx Key	RH Anvil	LH Anvil
SER 2020 K16D	16	20	20	125	21.0	25	38	S16	A16	K16	AE16	AI16
SER 2525 M16D	16	25	25	150	21.0	32	38	S16	A16	K16	AE16	AI16
SER 2525 M22D	22	25	25	150	21.0	32	38	S22	A22	K22	AE22	AI22

Gang Toolholders

Gang Toolholders are External Holders, used in small automatic machines with a gang tool post.

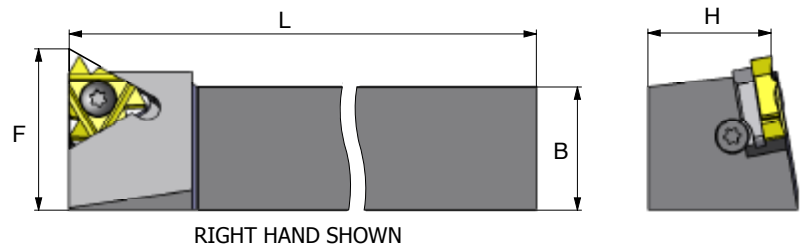
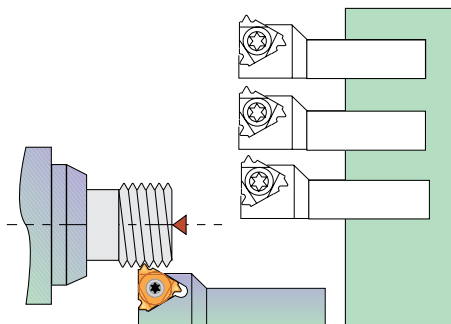

Ordering Code Right Hand	 L	B=H	L	F	Insert Screw	Anvil Screw	Torx Key	RH Anvil	LH Anvil
*SER 8 8 H11G	11	8	100	12.0	S11	-	K11	-	-
*SER 1010 H11G	11	10	100	14.0	S11	-	K11	-	-
SER 1616 K16G	16	16	125	21.7	S16	A16	K16	AE16	AI16
SER 2020 K16G	16	20	125	26.2	S16	A16	K16	AE16	AI16

*Toolholders with no anvil

For **LEFT HAND** toolholders specify **SEL** instead of **SER**

x-tream Jet External Toolholder with Internal Coolant

Carmex has developed a unique external thread turning holder with internal coolant to the cutting edge.

The holder includes two connecting options through an elbow fitting and a top clamp directing the coolant flow to the cutting edge.

The coolant flow provides:

- Better chip control and chip flow
- Longer tool life and high performance
- Reduces the cutting edge temperature
- Available RH and LH toolholders
- Coated holders provide abrasive resistance

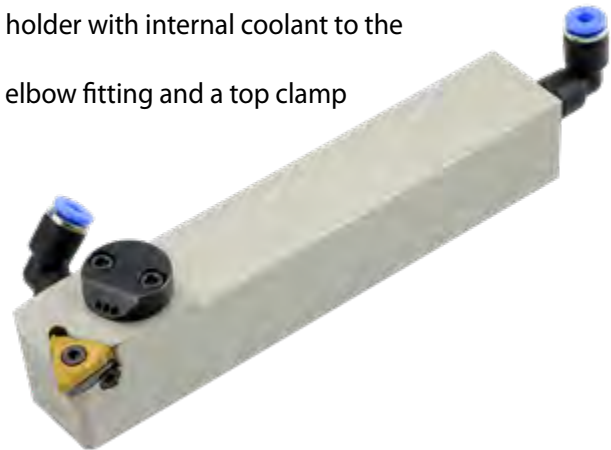

Demonstration

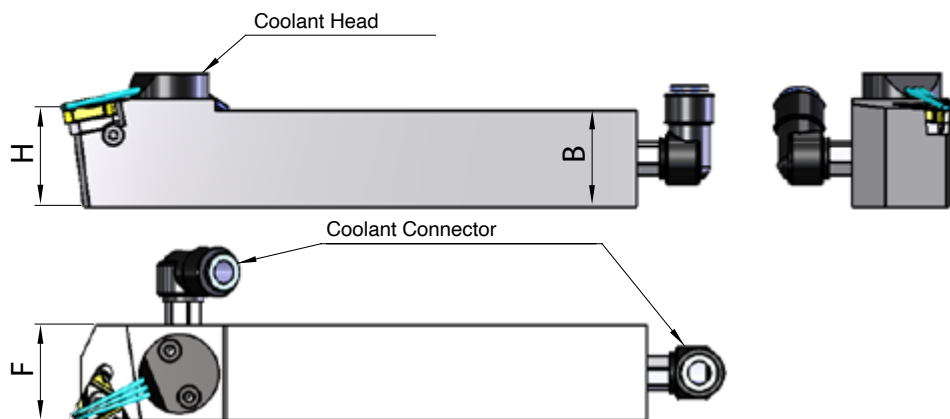

Ordering Code	 L mm	B=H	L	F	Insert Screw Torx +	Anvil Screw Torx +	Key Torx +	RH Anvil	LH Anvil	Coolant head	Coolant* Connector mm
SER 1616 H16B	16	16	100	16	S16P	A16P	K16P	AE16	AI16	CH3	Ø4/Ø6
SER 2020 K16B	16	20	125	20	S16P	A16P	K16P	AE16	AI16	CH1	Ø4/Ø6
SER 2525 M16B	16	25	150	25	S16P	A16P	K16P	AE16	AI16	CH1	Ø4/Ø6
SER 2525 M22B	22	25	150	25	S22P	A22P	K22P	AE22	AI22	CH1	Ø4/Ø6
SER 2525 M27B	27	25	150	32	S27P	A27P	K27P	AE27	AI27	CH1	Ø4/Ø6
SER 3232 P16B	16	32	170	32	S16P	A16P	K16P	AE16	AI16	CH1	Ø4/Ø6
SER 3232 P22B	22	32	170	32	S22P	A22P	K22P	AE22	AI22	CH1	Ø4/Ø6
SER 3232 P27B	27	32	170	32	S27P	A27P	K27P	AE27	AI27	CH1	Ø4/Ø6

For **LEFT HAND** toolholders specify **SEL** instead of **SER**

Toolholders made with 1.5° helix angle

Please consult the helix angle chart page A04-7 in the technical section of this catalog

* Standard packing with Ø6 mm

Internal Toolholders

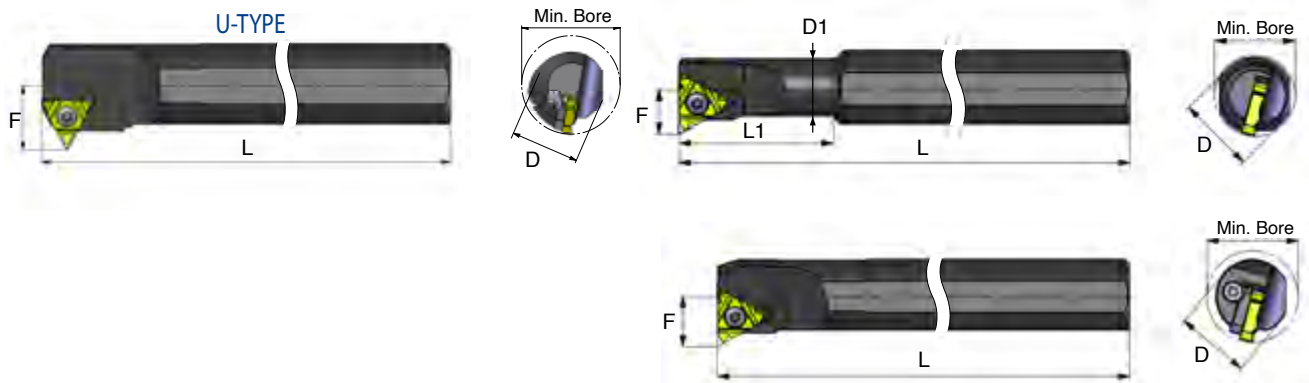

Ordering Code Right Hand		L	D	D1	Min Bore Diam.	L	L1	F	Insert Screw	Anvil Screw	Torx Key	RH Anvil	LH Anvil
*SIR 0005 H06		6	12	5.1	6.0	100	12	4.3	S06	-	K06	-	-
*SIR 0007 K08		8	16	6.6	7.8	125	18	5.3	S08	-	K08	-	-
*SIR 0008 K08U		8U	16	7.3	9.0	125	21	6.6	S08	-	K08	-	-
*SIR 0010 H11		11	10	10	12	100	-	7.4	S11	-	K11	-	-
*SIR 0010 K11		11	16	10	12	125	25	7.4	S11	-	K11	-	-
*SIR 0013 L11		11	16	13	15	140	32	8.9	S11	-	K11	-	-
*SIR 0013 M16		16	16	13	16	150	32	10.2	S16S	-	K16	-	-
*SIR 0016 P16		16	20	16	19	170	40	11.7	S16S	-	K16	-	-
SIR 0020 P16		16	20	20	24	170	-	13.7	S16	A16	K16	AI16	AE16
SIR 0025 R16		16	25	25	29	200	-	16.2	S16	A16	K16	AI16	AE16
SIR 0032 S16		16	32	32	36	250	-	19.7	S16	A16	K16	AI16	AE16
SIR 0040 T16		16	40	40	44	300	-	23.7	S16	A16	K16	AI16	AE16
SIR 0050 U16		16	50	50	54	350	-	28.7	S16	A16	K16	AI16	AE16
*SIR 0020 P22		22	20	20	24	170	-	15.6	S22S	-	K22	-	-
SIR 0025 R22		22	25	25	29	200	-	18.1	S22	A22	K22	AI22	AE22
SIR 0032 S22		22	32	32	38	250	-	21.6	S22	A22	K22	AI22	AE22
SIR 0040 T22		22	40	40	46	300	-	25.6	S22	A22	K22	AI22	AE22
SIR 0050 U22		22	50	50	56	350	-	30.6	S22	A22	K22	AI22	AE22
SIR 0032 S22U		22U	32	32	38	250	-	24.4	S22	A22	K22	AI22U	AE22U
SIR 0040 T22U		22U	40	40	46	300	-	28.1	S22	A22	K22	AI22U	AE22U
SIR 0050 U22U		22U	50	50	57	350	-	30.8	S22	A22	K22	AI22U	AE22U
SIR 0032 S27		27	32	32	40	250	-	22.6	S27	A27	K27	AI27	AE27
SIR 0040 T27		27	40	40	48	300	-	26.6	S27	A27	K27	AI27	AE27
SIR 0050 U27		27	50	50	58	350	-	31.6	S27	A27	K27	AI27	AE27
SIR 0060 V27		27	60	60	68	400	-	36.6	S27	A27	K27	AI27	AE27
SIR 0032 S27U		27U	32	32	40	250	-	25.8	S27	A27	K27	AI27U	AE27U
SIR 0040 T27U		27U	40	40	48	300	-	29.4	S27	A27	K27	AI27U	AE27U
SIR 0050 U27U		27U	50	50	58	350	-	34.4	S27	A27	K27	AI27U	AE27U
SIR 0060 V27U		27U	60	60	68	400	-	39.7	S27	A27	K27	AI27U	AE27U
*SIR 0050 U33U		33U	50	50	62	350	-	37.5	S33	-	K33	-	-

*Toolholders with no anvil

For **LEFT HAND** toolholders specify **SIL** instead of **SIR**

Toolholders are made with a **1.5° Helix Angle**. For other Helix Angles please see helix angle chart (page A04-7) in the technical section of this catalog.

Internal Toolholders with Coolant Bore

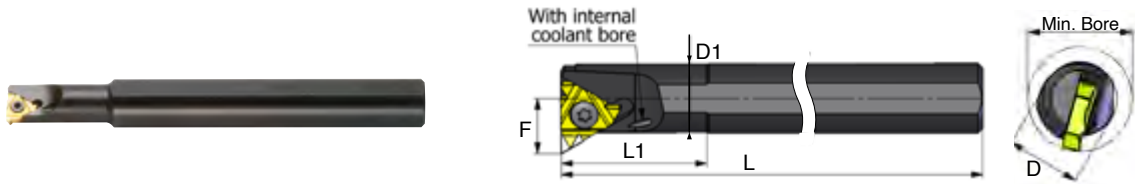

Ordering Code Right Hand	 L	D	D1	Min Bore Diam.	L	L1	F	Insert Screw	Anvil Screw	Torx Key	RH Anvil	LH Anvil
*SIR 0010 K11B	11	16	10	12	125	25	7.4	S11	-	K11	-	-
*SIR 0013 M16B	16	16	13	16	150	32	10.2	S16S	-	K16	-	-
*SIR 0016 P16B	16	20	16	19	170	40	11.7	S16S	-	K16	-	-
SIR 0020 P16B	16	20	20	24	170	-	13.7	S16	A16	K16	AI16	AE16
SIR 0025 R16B	16	25	25	29	200	-	16.2	S16	A16	K16	AI16	AE16
SIR 0025 R22B	22	25	25	29	200	-	18.1	S22	A22	K22	AI22	AE22
SIR 0032 S16B	16	32	32	36	250	-	19.7	S16	A16	K16	AI16	AE16

*Toolholders without anvil

For **LEFT HAND** toolholders specify **SIL** instead of **SIR**

Toolholders are made with a **1.5° Helix Angle**. For other Helix Angles please see helix angle chart (page A04-7) in the technical section of this catalog.

Internal Toolholders with Top Clamp



Ordering Code Right Hand	 L	D	D1	Min Bore Diam.	L	L1	F	Insert Screw	Clamp	Anvil Screw	Torx Key	RH Anvil	LH Anvil
DIR 0020 P16	16	20	20	24	170	-	13.7	S16	C16	A16S	K16	AI16	AE16
DIR 0025 R16	16	25	25	29	200	-	16.2	S16	C16	A16S	K16	AI16	AE16
DIR 0032 S16	16	32	32	36	250	-	19.7	S16	C16	A16S	K16	AI16	AE16
* DIR 0025 R22	22	25	25	29	200	-	18.1	S22	C22	A22	K22	AI22	AE22

For **LEFT HAND** toolholders specify **DIL** instead of **DIR**

Two clamping methods can be used: screw or top clamp.

*Use K21 torx key for C22 clamp

Toolholders with 3.5° Helix Angle

Ordering Code Right Hand	 L	D	D1	Min Bore Diam. mm	L	L1	F	Insert Screw	Torx Key
SIR 0016 P16B-3.5	16	20	16	19	170	40	13.7	S16S	K16
SIR 0020 P22B-3.5	22	20	20	24	170	-	15.6	S22S	K22

For **LEFT HAND** toolholders specify **SIL** instead of **SIR**

Special Thread Turning Applications

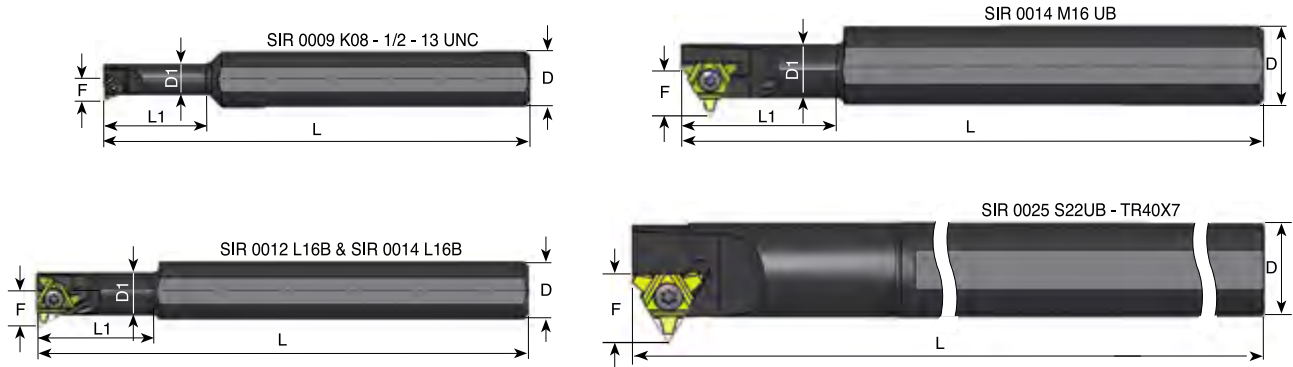



Ordering Code Right Hand		D	D1	L	L1	F	Thread	Insert Screw	Torx Key
*SIR 0009 K08	8	16	8.7	125	30	6.5	1/2 - 13UNC	S08	K08
SIR 0012 L16B	16	20	11.5	140	33	10.5	TR18x4	S16S	K16
SIR 0014 L16B	16	20	12.5	140	36	21.1	TR20x4	S16S	K16
SIR 0014 M16UB	16	20	13.5	150	40	13.2	TR22x5	S16S	K16
SIR 0025 S22UB	22	25	-	250		19.5	TR40x7	S22S	K22

For LH holders call Carmex
* Only right hand available

Carbide Shank Threading Bars With coolant bore

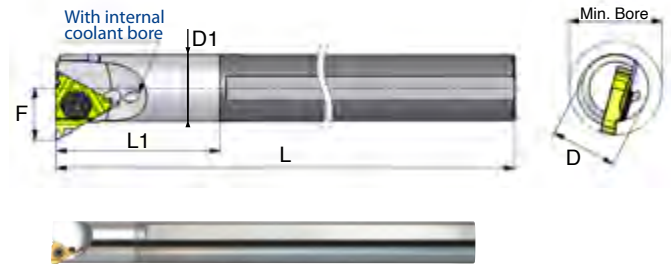
Carbide Shank Threading Bars are used when chatter and deflection are expected due to long overhang in deep small bores.



Ordering Code Right Hand	 L	D	D1	Min Bore Diam.	L	L1	F	Insert Screw	Anvil Screw	Torx Key	RH Anvil	LH Anvil
SIR 0005 H06CB	6	6	5.1	6.0	100	26	4.3	S06	-	K06	-	-
SIR 0007 K08CB	8	8	6.6	7.8	125	31	5.3	S08	-	K08	-	-
SIR 0008 K08UCB	8U	8	7.3	9.0	125	35	6.6	S08	-	K08	-	-
SIR 0010 M11CB	11	10	10	12	150	-	7.4	S11	-	K11	-	-
SIR 0012 P11CB	11	12	12	15	170	-	8.4	S11	-	K11	-	-
SIR 0016 R16CB	16	16	16	19	200	-	11.7	S16S	-	K16	-	-
*SIR 0020 S16CB	16	20	20	24	250	-	13.7	S16	A16	K16	AI16	AE16
*SIR 0025 S16CB	16	25	25	29	250	-	16.2	S16	A16	K16	AI16	AE16
**SIR 0020 S22CB	22	20	19.3	24	250	100	15.6	S22	-	K22	-	-

* Carbide shank Threading bars with anvil

** Helix angle: 3.5°

For **LEFT HAND** toolholders specify **SIL** instead of **SIR**

Vertical Toolholders

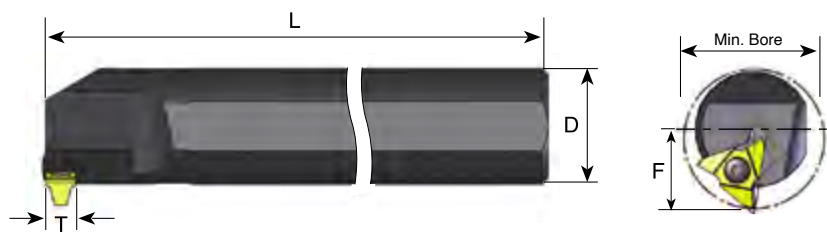



Ordering Code Right Hand	 L	D	* Min Bore Diam.	L	F	Insert Screw	Torx Key
SIR 0040T27V-T10	27	40	48	300	29	S27	K27
SIR 0050U27V-T10	27	50	58	350	34	S27	K27

* To be compared with given minimum bore profile.

For **LEFT HAND** toolholders specify **SIL** instead of **SIR**

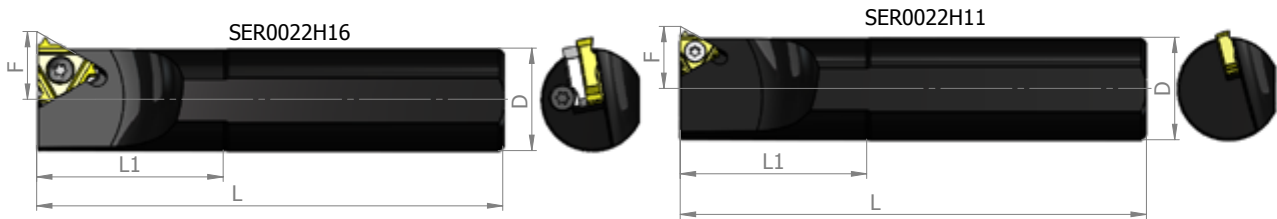
Star Toolholders Ø22



Ordering Code Right Hand		D	L	L1	F	Insert Screw	Anvil Screw	Torx Key	RH Anvil	LH Anvil
SER 0022 H11	11	22	100	40	13.3	S11	-	K11	-	-
SER 0022 H16	16	22	100	40	14.6	S16	A16	K16	AE16	AI16

For **LEFT HAND** toolholders specify **SEL** instead of **SER**

Modular Line

Turning adaptors and boring bars
for internal applications of threading and grooving.



Advantages

- High accurate turning ML adaptors provide full flexibility and easy adjustment.
- Full repeatability.
- A single boring bar fits to multi ML adaptors.
- Reduces tool inventories - investing in a single boring bar, right and left hand ML adaptors from the same size.
- ML adaptors support all Carmex standard thread turning inserts sizes 16, 22 and 27 mm. Grooving inserts size 16 mm fit the MLR/L 16 - 32 and MLR / L 16 - 40 adaptors.
- ML adaptors are coated with a high abrasive resistant nickel layer to prolong the ML adaptors tool life.

Applications

- Internal machining
- Deep threads require high overhang with maximum rigidity
- Grooving
- Can be used on a large range of turning or multi-task machines

High pressure coolant

ML boring bars and adaptors are designed with internal coolant allowing high pressure up to 120 Bar.

High pressure coolant reduces the cutting edge temperature, provides a better chip evacuation and improves tool life.

The tools can also be used with normal coolant pressure.

Applications

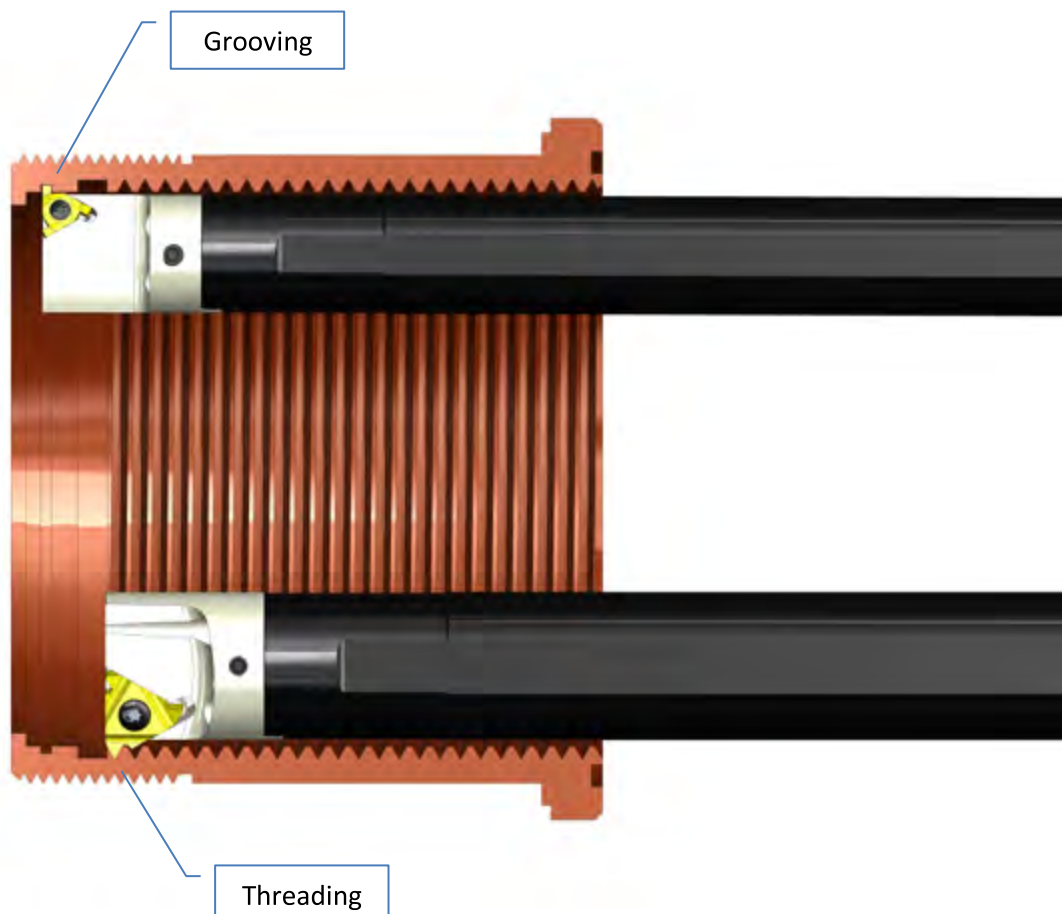

- Maximum overhang: 4 x D

Product Identification

ML Turning adaptors

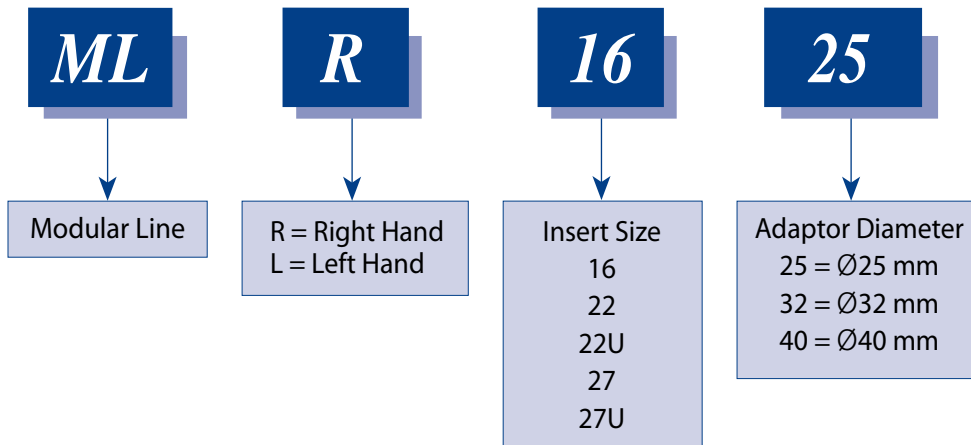

Boring Bars

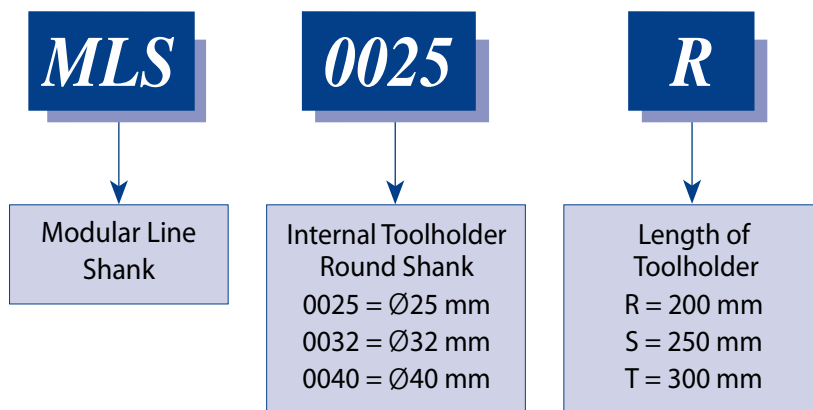

ML Turning Adaptors

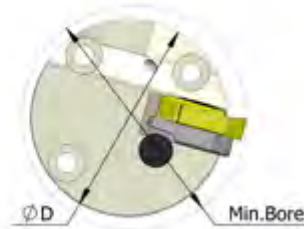
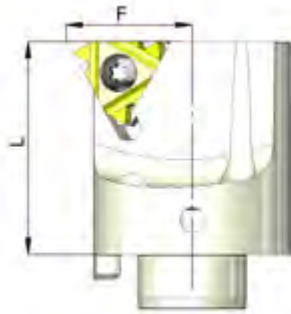

D	Ordering Code	 L	I.C. in	Min Bore Diam.	L	F	Insert Screw	Anvil Screw	Torx Key	RH Anvil	LH Anvil
25	*MLR 16 - 25	16	3/8	29	30	16.2	S16P	-	K16P	-	-
25	*MLR 22 - 25	22	1/2	29	30	18.1	S22P	-	K22P	-	-
32	MLR 16 - 32	16	3/8	36	43	19.7	S16P	A16P	K16P	AI16	AE16
32	MLR 22 - 32	22	1/2	38	43	21.6	S22P	A22P	K22P	AI22	AE22
32	MLR 22U - 32	22U	1/2U	38	43	24.4	S22P	A22P	K22P	AI22U	AE22U
40	MLR 16 - 40	16	3/8	44	43	23.7	S16P	A16P	K16P	AI16	AE16
40	MLR 22 - 40	22	1/2	46	43	25.6	S22P	A22P	K22P	AI22	AE22
40	MLR 22U - 40	22U	1/2U	46	43	28.1	S22P	A22P	K22P	AI22	AE22
40	MLR 27 - 40	27	5/8	48	43	26.6	S27P	A27P	K27P	AI27	AE27
40	MLR 27U - 40	27U	5/8U	48	43	29.4	S27P	A27P	K27P	AI27U	AE27U

*Toolholders with no anvil

For **LEFT HAND** toolholders specify **MLL** instead of **MLR**

Boring Bars

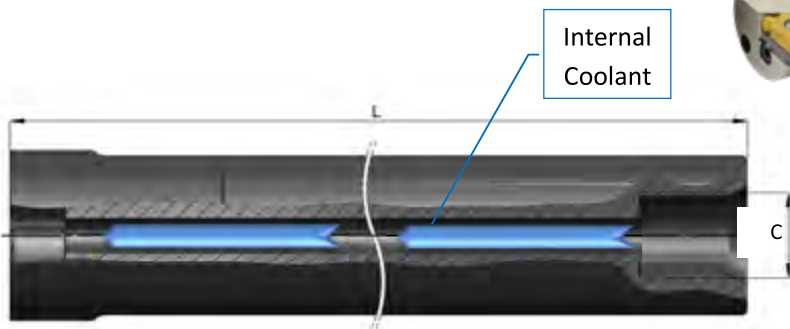

Internal Coolant



D	Ordering Code	L	H	C	Screw	Key
25	MLS 0025 R	200	23	G1/4"	S420, S435	K3
32	MLS 0032 S	250	30	G3/8"	S520, S550	K4
40	MLS 0040 T	300	36	G1/2"	S520, S550	K4

External ML adaptors (for external threads) are available upon request and can be used on the same MLS boring bars.

Quick Change Polygon Threading Toolholders

- Polygon shank
- ISO standard (26623) compliant for toolholding systems
- Polygon taper ensures automatic radial centering and even pressure around the coupling
- Enable quick tool changes ISO standard coupling system with a 1.4 degree tapered polygon shank design
- Interchangeable with leading manufacturers

External Toolholders

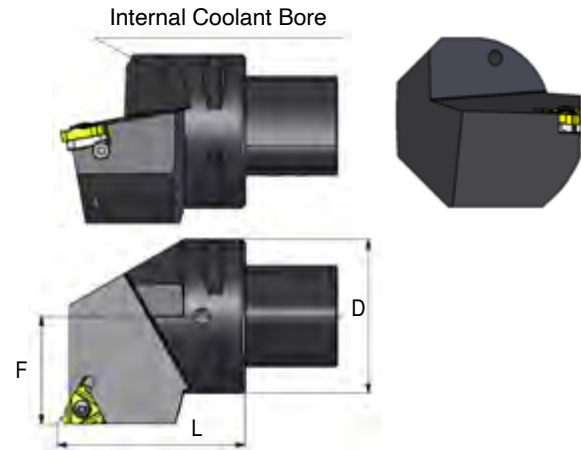

Equivalent to...	Ordering Code		D	F	L	Insert Screw	Anvil Screw	Torx key	RH Anvil	LH Anvil
C4	P40-SER 27050-16	16	40	27	50	S16	A16	K16	AE16	AI16
C5	P50-SER 35060-16	16	50	35	60	S16	A16	K16	AE16	AI16
C6	P63-SER 45065-16	16	63	45	65	S16	A16	K16	AE16	AI16
C4	P40-SER 27050-22	22	40	27	50	S22	A22	K22	AE22	AI22
C5	P50-SER 35060-22	22	50	35	60	S22	A22	K22	AE22	AI22
C6	P63-SER 45065-22	22	63	45	65	S22	A22	K22	AE22	AI22
C8	P80-SER 55080-16	16	80	55	80	S16	A16	K16	AE16	AI16
C8	P80-SER 55080-22	22	80	55	80	S22	A22	K22	AE22	AI22
C6	P63-SER 45065-27	27	63	45	65	S27	A27	K27	AE27	AI27

For **LEFT HAND** toolholders specify **SEL** instead of **SER**

Internal Toolholders

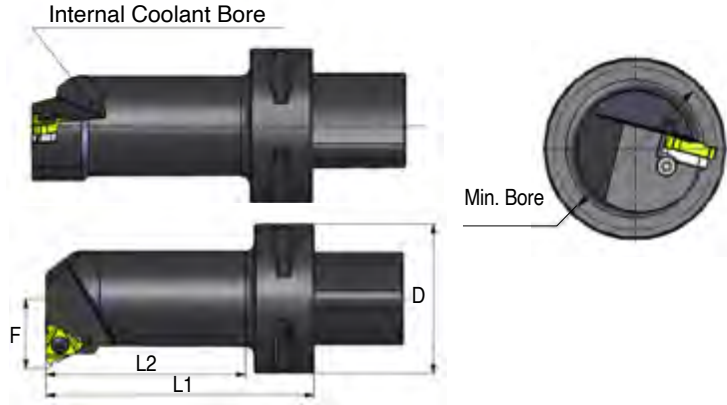

Equivalent to...	Ordering Code		D	F	Min. Bore Dia.	L1	L2	Insert Screw	Anvil Screw	Torx key	RH Anvil	LH Anvil
C4	* P40-SIR 12060-16	16	40	11.7	20	60	37	S16	-	K16	-	-
	P40-SIR 14060-16	16	40	13.5	25	60	38	S16	A16	K16	AI16	AE16
	P40-SIR 17070-16	16	40	16.0	29	70	48	S16	A16	K16	AI16	AE16
	P40-SIR 22090-16	16	40	19.5	36	90	69	S16	A16	K16	AI16	AE16
	P40-SIR 27080-16	16	40	23.5	44	80	60	S16	A16	K16	AI16	AE16
C5	* P50-SIR 12060-16	16	50	11.7	20	60	35	S16	-	K16	-	-
	P50-SIR 14060-16	16	50	13.5	25	60	36	S16	A16	K16	AI16	AE16
	P50-SIR 17070-16	16	50	16.0	29	70	47	S16	A16	K16	AI16	AE16
	P50-SIR 22090-16	16	50	19.5	36	90	68	S16	A16	K16	AI16	AE16
	P50-SIR 27105-16	16	50	23.5	44	105	84	S16	A16	K16	AI16	AE16
C6	P63-SIR 14070-16	16	63	13.5	25	70	42	S16	A16	K16	AI16	AE16
	P63-SIR 17075-16	16	63	16.0	29	75	48	S16	A16	K16	AI16	AE16
	P63-SIR 22090-16	16	63	19.5	36	90	64	S16	A16	K16	AI16	AE16
	P63-SIR 27105-16	16	63	23.5	44	105	80	S16	A16	K16	AI16	AE16
C4	* P40-SIR 15065-22	22	40	15.4	25	65	42	S22	-	K22	-	-
	P40-SIR 19070-22	22	40	17.9	29	70	48	S22	A22	K22	AI22	AE22
	P40-SIR 22090-22	22	40	21.4	38	90	69	S22	A22	K22	AI22	AE22
	P40-SIR 27080-22	22	40	25.4	46	80	60	S22	A22	K22	AI22	AE22
C5	* P50-SIR 15065-22	22	50	15.4	25	65	41	S22	-	K22	-	-
	P50-SIR 19070-22	22	50	17.9	29	70	47	S22	A22	K22	AI22	AE22
	P50-SIR 22090-22	22	50	21.4	38	90	68	S22	A22	K22	AI22	AE22
	P50-SIR 27105-22	22	50	25.4	46	105	84	S22	A22	K22	AI22	AE22
C6	P63-SIR 19075-22	22	63	17.9	29	75	48	S22	A22	K22	AI22	AE22
	P63-SIR 22090-22	22	63	21.4	38	90	64	S22	A22	K22	AI22	AE22
	P63-SIR 27105-22	22	63	25.4	46	105	80	S22	A22	K22	AI22	AE22

For **LEFT HAND** toolholders specify **SIL** instead of **SIR**

* Holders without anvil

Thread Helix Angle

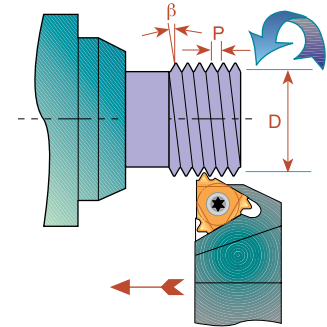
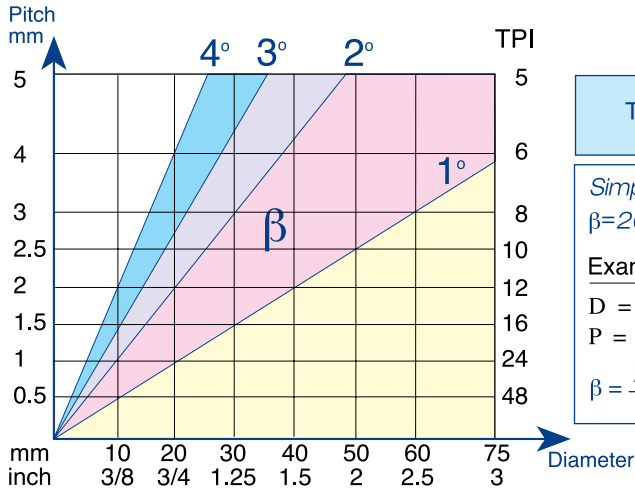

Standard and Slanted Anvils

Carmex Toolholder Pockets have a built in 1.5° helix angle. This angle may be adjusted to better match the thread helix angle by simply changing the anvil.

Negative helix is usually used when threading RH thread with LH Holder or LH thread with RH Holder.

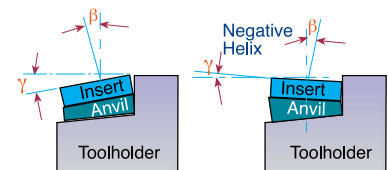

L	IC	Pocket Angle γ	4.5°	3.5°	2.5°	1.5° Standard	0.5°	-0.5°	-1.5°
16	3/8	EX-RH OR IN-LH	AE16+4.5	AE16+3.5	AE16+2.5	AE16	AE16+0.5	AE16-0.5	AE16-1.5
16	3/8	EX-LH OR IN-RH	AI 16+4.5	AI 16+3.5	AI 16+2.5	AI 16	AI 16+0.5	AI 16-0.5	AI 16-1.5
22	1/2	EX-RH OR IN-LH	AE22+4.5	AE22+3.5	AE22+2.5	AE22	AE22+0.5	AE22-0.5	AE22-1.5
22	1/2	EX-LH OR IN-RH	AI 22+4.5	AI 22+3.5	AI 22+2.5	AI 22	AI 22+0.5	AI 22-0.5	AI 22-1.5
22U	1/2U	EX-RH OR IN-LH	AE22U+4.5	AE22U+3.5	AE22U+2.5	AE22U	AE22U+0.5	AE22U-0.5	AE22U-1.5
22U	1/2U	EX-LH OR IN-RH	AI 22U+4.5	AI 22U+3.5	AI 22U+2.5	AI 22U	AI 22U+0.5	AI 22U-0.5	AI 22U-1.5
27	5/8	EX-RH OR IN-LH	AE27+4.5	AE27+3.5	AE27+2.5	AE27	AE27+0.5	AE27-0.5	AE27-1.5
27	5/8	EX-LH OR IN-RH	AI 27+4.5	AI 27+3.5	AI 27+2.5	AI 27	AI 27+0.5	AI 27-0.5	AI 27-1.5
27U	5/8U	EX-RH OR IN-LH	AE27U+4.5	AE27U+3.5	AE27U+2.5	AE27U	AE27U+0.5	AE27U-0.5	AE27U-1.5
27U	5/8U	EX-LH OR IN-RH	AI 27U+4.5	AI 27U+3.5	AI 27U+2.5	AI 27U	AI 27U+0.5	AI 27U-0.5	AI 27U-1.5

Anvil Kits

5 AE and 5 AI anvils with various helix angles

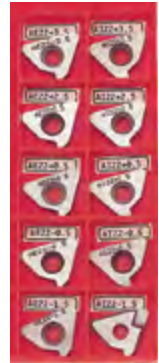

AE (FOR EX.RH. & IN.LH.) AI (FOR IN.RH. & EX.LH.)

Ordering Code	Contents				
KA16	AE16+4.5	AE16+3.5	AE16+2.5	AE16+0.5	AE16-1.5
	AI 16+4.5	AI 16+3.5	AI 16+2.5	AI 16+0.5	AI 16-1.5
KA22	AE22+4.5	AE22+3.5	AE22+2.5	AE22+0.5	AE22-1.5
	AI 22+4.5	AI 22+3.5	AI 22+2.5	AI 22+0.5	AI 22-1.5
KA22U	AE22U+4.5	AE22U+3.5	AE22U+2.5	AE22U+0.5	AE22U-1.5
	AI 22U+4.5	AI 22U+3.5	AI 22U+2.5	AI 22U+0.5	AI 22U-1.5
KA27	AE27+4.5		AE27+2.5		AE27-1.5
	AI 27+4.5		AI 27+2.5		AI 27-1.5
KA27U	AE27U+4.5		AE27U+2.5		AE27U-1.5
	AI 27U+4.5		AI 27U+2.5		AI 27U-1.5

Standard Kits

Threading Kits are a versatile solution for users that cut a variety of thread types in limited quantity and do not want to sacrifice thread quality.

External ISO Kit Ordering Code: KEG

INSERTS

16 ER A60 P25C
 16 ER G60 P25C
 16 ER 0.75 ISO P25C
 16 ER 1.0 ISO P25C
 16 ER 1.25 ISO P25C
 16 ER 1.5 ISO P25C
 16 ER 1.75 ISO P25C
 16 ER 2.0 ISO P25C
 16 ER 2.5 ISO P25C
 16 ER 3.0 ISO P25C

TOOLHOLDERS

SER 2020 K16
 KEY
 K16
 SCREW
 S16

Internal ISO Kit Ordering Code: KIG

INSERTS

16 IR A60 P25C
 16 IR G60 P25C
 16 IR 0.75 ISO P25C
 16 IR 1.0 ISO P25C
 16 IR 1.25 ISO P25C
 16 IR 1.5 ISO P25C
 16 IR 1.75 ISO P25C
 16 IR 2.0 ISO P25C
 16 IR 2.5 ISO P25C
 16 IR 3.0 ISO P25C

TOOLHOLDERS

SIR 0020 P16
 KEY
 K16
 SCREW
 S16



If a larger toolholder with a 25 mm shank is required, add to the kit 25. For example: KIG - 25
 BMA grade is also available. For example: KEG - BMA

Miniature & Ultra-Miniature Kits



Ordering Code	Type	No. of Inserts	Inserts	Contents Boring Bar	Key
KU60M - BXC	ULTRA	10	06 IR A60 BXC	SIR 0005 H06	K6
KM60M - BXC	MINI	10	08 IR A60 BXC	SIR 0007 K08	K8

Inserts' Kits

Type B Kits

Type B threading inserts.
A combination of ground profile and sintered chip-breaker threading inserts.
BMA Grade: Sub-Micron carbide grade with TiAlN multi-layer Coating.

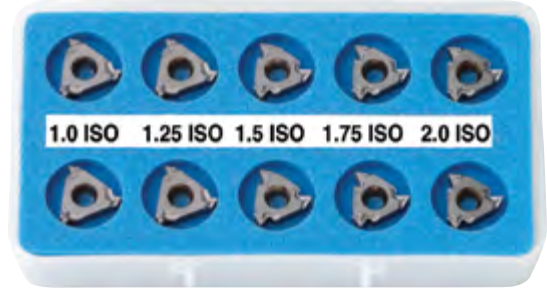

EXTERNAL ISO KIT KEMB - BMA

- 16 ER B 1.0 ISO BMA-2 Pcs
- 16 ER B 1.25 ISO BMA-2 Pcs
- 16 ER B 1.5 ISO BMA-2 Pcs
- 16 ER B 1.75 ISO BMA-2 Pcs
- 16 ER B 2.0 ISO BMA-2 Pcs



EX-RH

INTERNAL ISO KIT KIMB - BMA

- 16 IR B 1.0 ISO BMA-2 Pcs
- 16 IR B 1.25 ISO BMA-2 Pcs
- 16 IR B 1.5 ISO BMA-2 Pcs
- 16 IR B 1.75 ISO BMA-2 Pcs
- 16 IR B 2.0 ISO BMA-2 Pcs



IN-RH

Standard Inserts' Kits

EXTERNAL ISO KIT

- 16 ER 1.0 ISO-2 Pcs
- 16 ER 1.25 ISO-2 Pcs
- 16 ER 1.5 ISO-2 Pcs
- 16 ER 1.75 ISO-2 Pcs
- 16 ER 2.0 ISO-2 Pcs

INTERNAL ISO KIT

- 16 IR 1.0 ISO-2 Pcs
- 16 IR 1.25 ISO-2 Pcs
- 16 IR 1.5 ISO-2 Pcs
- 16 IR 1.75 ISO-2 Pcs
- 16 IR 2.0 ISO-2 Pcs

Ordering Code: KEM

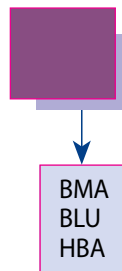

Ordering Code: KIM

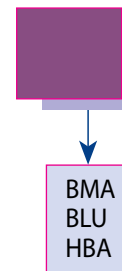

Threading & Boring Combination Kit

A practical and convenient combination kit for **Ultra Miniature** Threading and Boring. It enables Boring and Threading of mini bores as small as **6 mm diameter (1/4")** with just one deep reaching Carbide shank ultra mini Boring Bar.



Ordering Code	Contents			
	Threading Insert	Turning Inserts	Boring Bar	Key
KC6TM	06 IR A60 BXC 10 Pcs	06 IR TURN BMA 10 Pcs	SIR 0005 H06CB	K6

BMA - Coated carbide grade for medium to high cutting speeds

BXC - Coated carbide grade for low cutting speed - 40 to 90 m/min

CB - Carbide shank boring bar with coolant bore